

SUMITOMO

SH145X-6

MINIMUM SWING RADIUS

- Engine Rated Power (Net): 74.9 kW·101.8 PS
- Operating Weight:
 - SH145X-6.....14,600-15,100 kg
- Bucket: ISO/SAE/PCSA Heaped: 0.24-0.65 m³



SUMITOMO



**SUMITOMO (S.H.I.)
CONSTRUCTION MACHINERY CO., LTD.**

731-1 Naganumahara-cho, Inage-ku, Chiba, 263-0001 Japan
For further information please contact: Phone : +81-43-420-1829 Facsimile : +81-43-420-1907

We are constantly improving our products and therefore reserve the right to change designs and specifications without notice.
Illustrations may include optional equipment and accessories and may not include all standard equipment.

Performance Refined. Evolution Defined.

Engine and Hydraulics 04-07

- New Generation Engine System "SPACE 5+"
- New Hydraulic System "SIH:S+"
- SUMITOMO Fuel Efficiency Technology
- Dramatically Increased Productivity

Durability and Maintenance 08-09

- High Rigidity Attachments
- EMS
- Ground Level Maintenance

Safety and Operator Comfort 10-13

- ROPS Cabin
- Stylish and Spacious Cabin
- High-Definition Full Colour LCD Monitor

Specifications 14-19

MADE IN JAPAN

The world knows that Japanese designed, engineered and manufactured products represent the highest quality, especially for Industrial Products. The hydraulic excavator is no exception when a totally intergrated concept is required in design work involving key components, manufacturing engineering, and product quality assurance in the factory. Sumitomo is one of the largest business groups in Japan, tracing its roots back to the late 1600's when they started a mining and copper smelting business, and since then have expanded and diversified their business operations on a continuing basis. Sumitomo hydraulic excavators are designed and manufactured today to meet the global demands of our many customers with the concept of Performance, Reliability, and Fuel Efficiency foremost in our minds. This proven Japanese technology and quality gives SUMITOMO excavator customers total peace of mind and provide a complete solution for the demands of the construction industry.

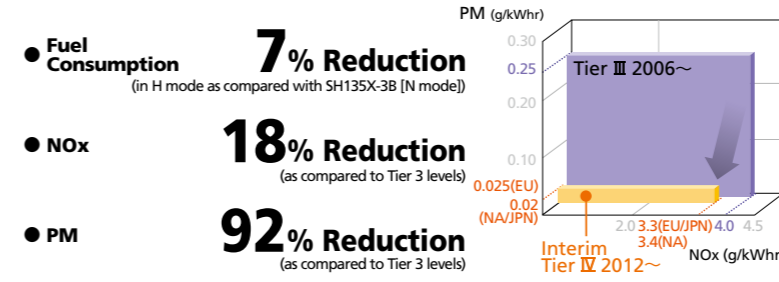

Compliant to Emission Regulations U.S. EPA Tier 4 Interim, EU Stage III B, and JPN Tier 4 Interim

The state-of-the-art engine system "SPACE 5+" substantially reduces NOx (nitrogen oxide) and PM (particulate matter) contained in the exhaust gas, further reducing or minimising the impact on the environment.

New Generation Engine System "SPACE 5+"

The new engine system optimises fuel efficiency and environmental performance via the advanced common rail fuel injection system, cooled EGR system, and VG (variable geometry) turbocharger. At the same time, excellent response times are achieved.

After-Treatment Technology: Diesel Particulate Diffuser (DPD)

DPD is an exhaust after-treatment device which traps and burns off PM in the exhaust gas. PM accumulation can be monitored by the DPD status gauge, and Auto Regeneration (filter cleaning) will be conducted at regular intervals.

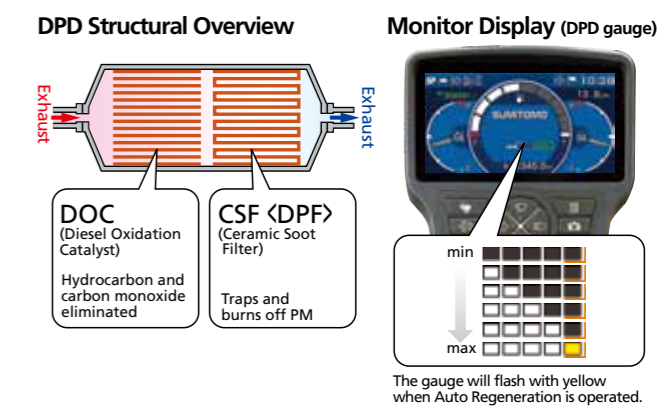
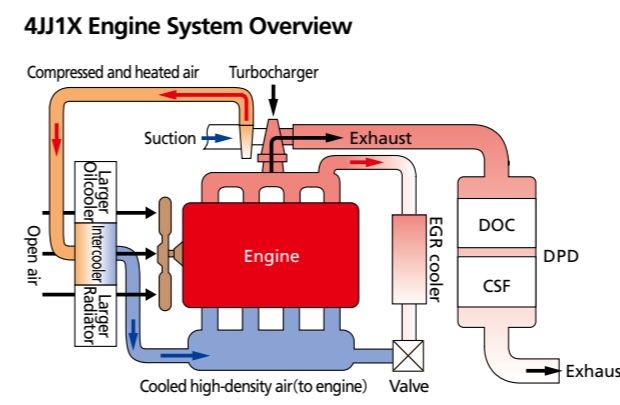

Mode Selection by Throttle **SUMITOMO UNIQUE DESIGN**

There are three new working modes available: SP (Super Power) for heavy duty applications, H (Heavy) for normal working conditions, and A (Auto) for a wide range of operations.



SUMITOMO Technology for Fuel Efficiency

- **SSC (Spool Stroke Control)** **SUMITOMO UNIQUE DESIGN**
Reduces engine load upon heavy duty operation.
- **PTR (Pump Transition Reduction)** **SUMITOMO UNIQUE DESIGN**
Decreases engine load when the pump flow requirement is reduced upon abrupt pump load.
- **BES (Boom-down Energy Save)** **SUMITOMO UNIQUE DESIGN**
Lowers engine speed upon boom-down and swing operation which does not require large oil flow.
- **AES (Auto Energy Save)** **SUMITOMO UNIQUE DESIGN**
Lowers engine speed accordingly when low engine load is sensed.

Engine and Hydraulics



SH145X-6 has achieved a 7% reduction in fuel consumption in comparison with our DASH 3B series, by fusing the new generation engine system "SPACE 5+" and the new hydraulic system "SIH:S+", further refining fuel efficiency. At the same time the newly developed ISUZU engine, which complies with emission regulations such as U.S. EPA Tier 4 Interim and EU Stage III B, contributes greatly to the environment.



New Engine System **SPACE 5+ PLUS** + New Hydraulic System **SIH:S+ PLUS** = **7% Reduction in Fuel Consumption**
(in H mode as compared with SH135X-3B [N mode])

Further Improvements to Fuel Consumption

Optimal control for economic operation has reduced fuel consumption by 7% in H mode.

ECO Gauge to Display Energy Efficiency Operation

An ECO Gauge and fuel consumption indicator are included within the monitor to make energy efficiency recognisable in an instant.



Idle Shut Down & Auto Idle

Upon activation, idle shut down automatically shuts the engine down when the machine is not in operation for set amount of time. Auto Idle is also available, which makes the engine begin idling approximately five seconds after the operation levers are in neutral position.



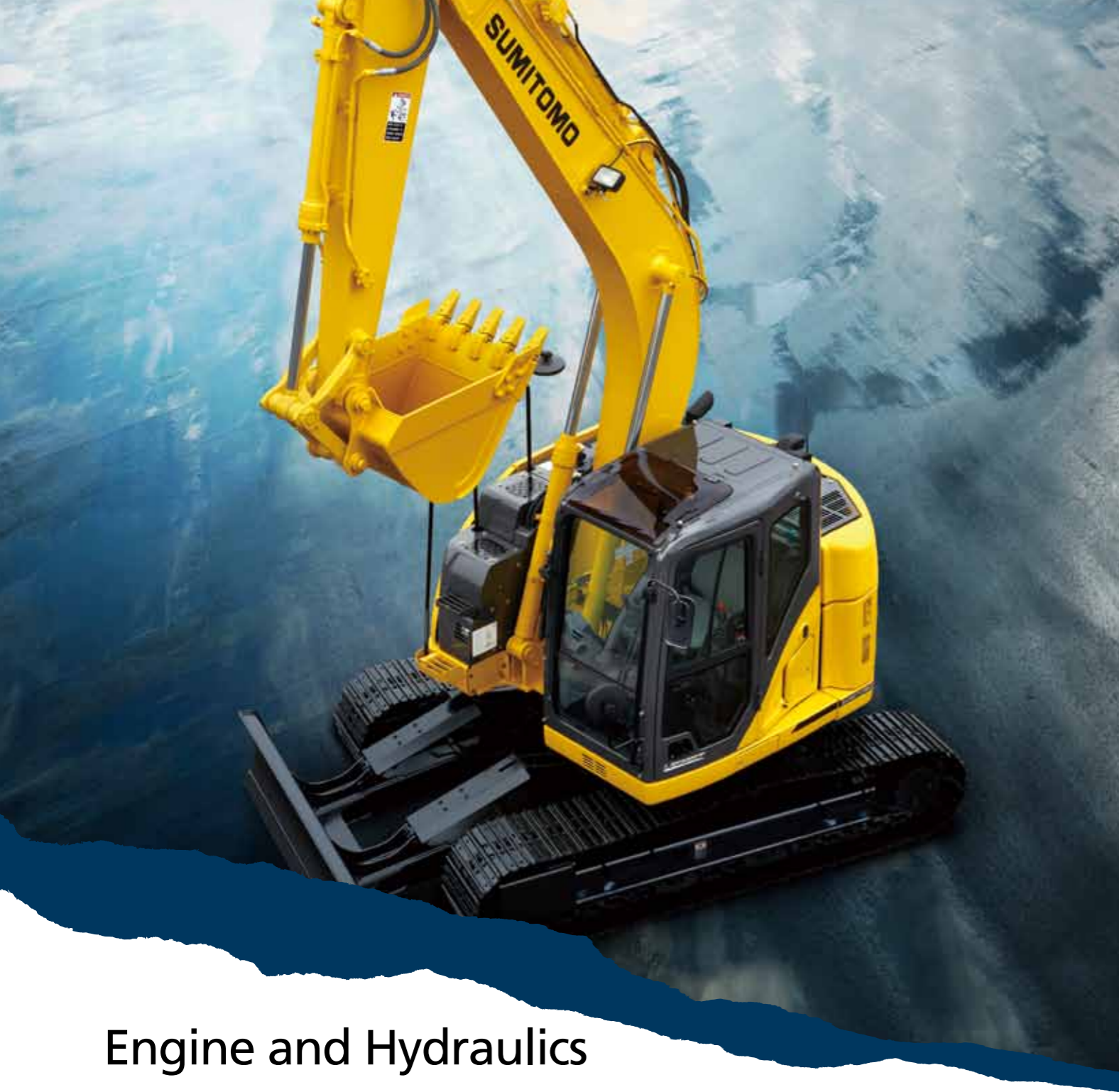

Engine and Hydraulics

SUMITOMO's original Spool Stroke Control (SSC) technology perfectly matches the engine and hydraulic power, and further improves the operational speed whilst maintaining smooth control of the machine.

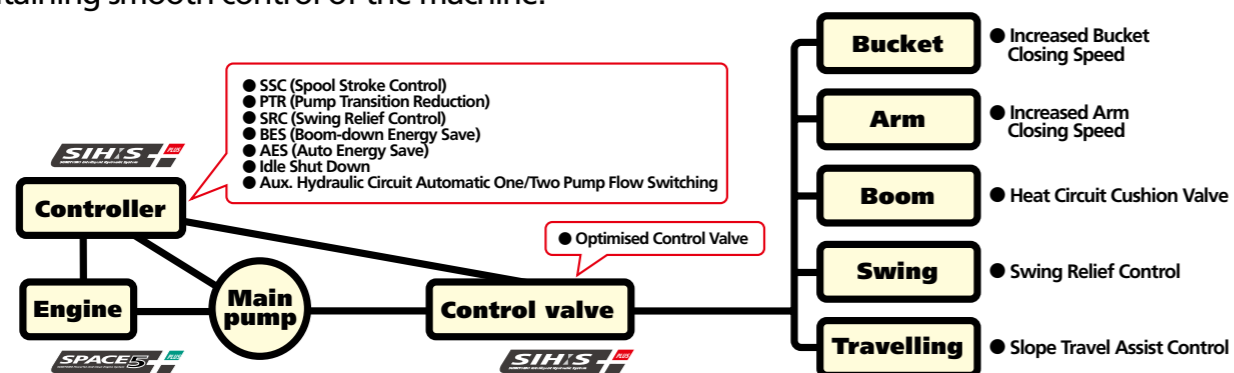

Small Rear Swing Suited to a Diverse Range of Jobs

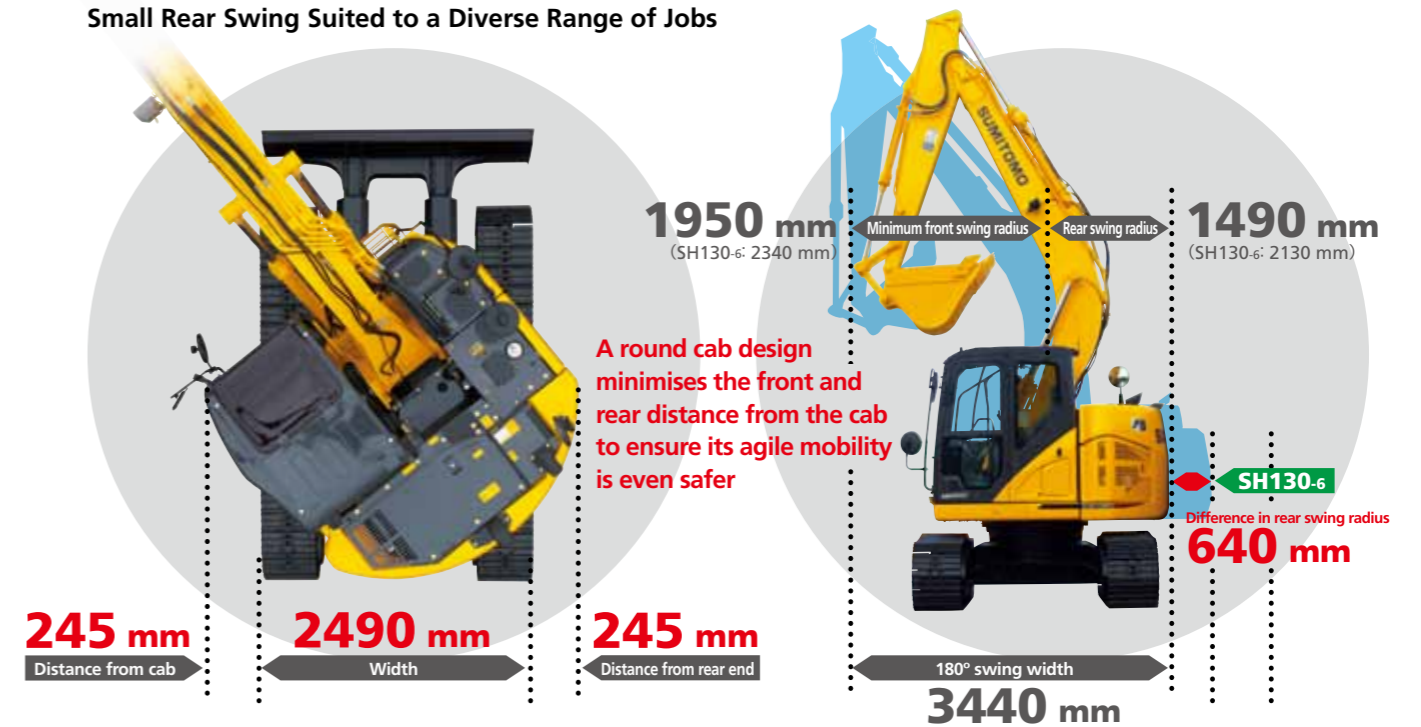

Note: The figures shown above are achieved when standard counterweights are installed. The minimum rear swing will differ to these figures when heavier counterweights are installed.

Work Efficiency Drastically Increased **SUMITOMO UNIQUE DESIGN**

Spool Stroke Control (SSC) variably controls spool port flow rate, depending on the condition of operation. Improved power, speed, and smoother controls mean that work efficiency is dramatically increased.

Shorter Cycle Time and Operability

A speed increase of 5% for cycle time (SP mode) has been achieved, compared with the SH135X-3B (N mode). Control also focuses on operability when delicate operations are required, ensuring both productivity and operability.

Horsepower Control and Increased Automatic Digging Power

The volume of the main pump has been increased by 10% for faster work speed and more flexibility with complex operations. Pump horsepower increases during heavy-duty digging, delivering sufficient power for stress-free operations.

Speed and Power, Dramatically Increases Productivity

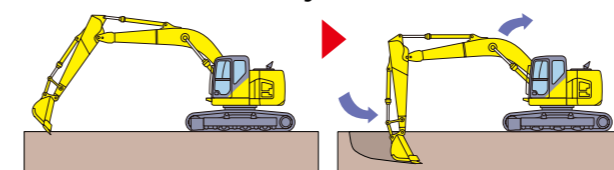

- SP mode **5% faster cycle time**
- A mode **7% faster cycle time**

(as compared with SH135X-3B. SP mode has been compared with N mode, and A mode with E mode) * Based on SUMITOMO's testing condition and results.

Remarkable Combined Operation

Prevents rapid deceleration upon combined operation such as attachment operation when travelling, ensuring stable performance.

Auxiliary Hydraulic Circuit

Selection of auxiliary circuit has been made easier. Correct pump flow (one pump or two pump) will automatically be activated upon operator's selection of the circuit.

Automatic Power Boost

The digging power increases automatically in quick response to the working conditions during heavy-duty digging work. This is a design unique to SUMITOMO, and continues for eight seconds (SP/H mode).

Operating Condition Easily Viewable on Display

Various control such as working modes and auxiliary hydraulic setting can be easily selected by the universally designed switch panel, and the selected mode can be easily viewed on the 7" wide monitor.



Durability and Maintenance

Serviceability and durability are also important points of machine performance. Ground level access to the engine area makes daily maintenance extremely straightforward. Reliability has been further enhanced by increasing cooling capability and durability.



EMS (Easy Maintenance System) as Standard

SUMITOMO's EMS keeps the pins and bushes fully lubricated at all times and prevents rattling. This system significantly extends the service life of the pins and bushes.

The lubrication interval around the bucket is 250 hours, and for the other sections is 1,000 hours, keeping the joints lubricated for a long time and extending the service life of parts by reducing abrasion and rattling.

- ➡ Sections equipped with steel EMS bushing
- ➡ Sections equipped with EMS bushing

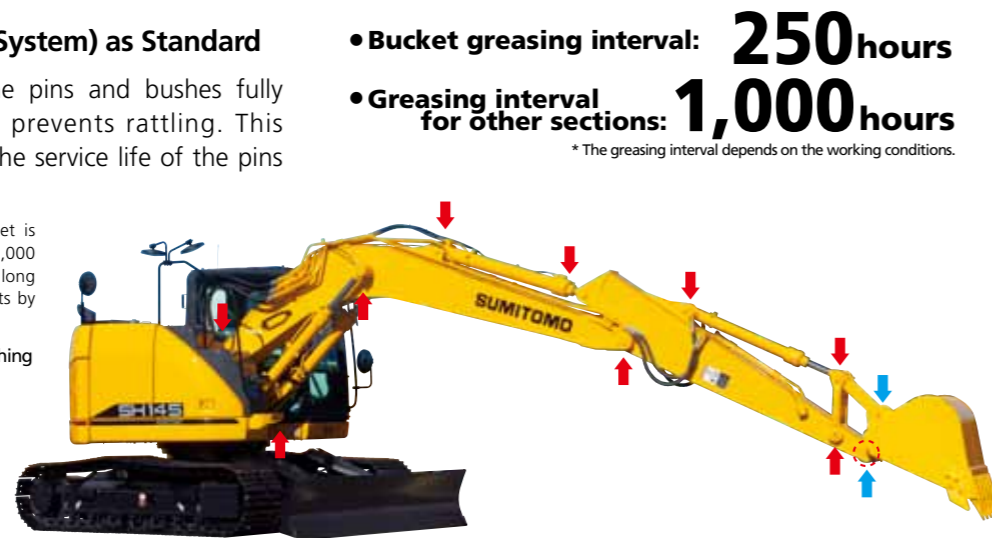

- **Bucket greasing interval: 250 hours**
 - **Greasing interval for other sections: 1,000 hours**
- * The greasing interval depends on the working conditions.

EMS bushing

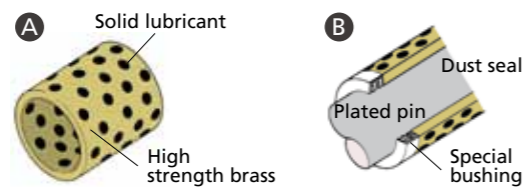

- ➡ **A** A solid lubricant embedded in high strength brass forms a layer on the bushing surface to prevent contact between metals, maintaining an excellent lubricated state to reduce abrasion of joints.
- ➡ **B** The surface of the pin is plated to increase the surface hardness and improve the wear resistance accordingly.

Steel EMS bushing



Steel EMS is installed around the bucket

Precautionary use of EMS

- ① Grease is enclosed, however greasing is necessary every 1000 hours or six months depending on the level of dusting conditions.
- ② Greasing is also necessary after any components have been submerged underwater for prolonged periods.
- ③ Greasing is also recommended after use with hydraulic breakers, crushers or other high impact attachments such as rock saws.
- ④ Bucket pins should be cleaned thoroughly when removing or attaching new buckets.

High Rigidity Attachments

The structure of the boom and arm has been further improved, ensuring strength and durability. In addition, high strength castings are used for the boom base and arm end, improving reliability.

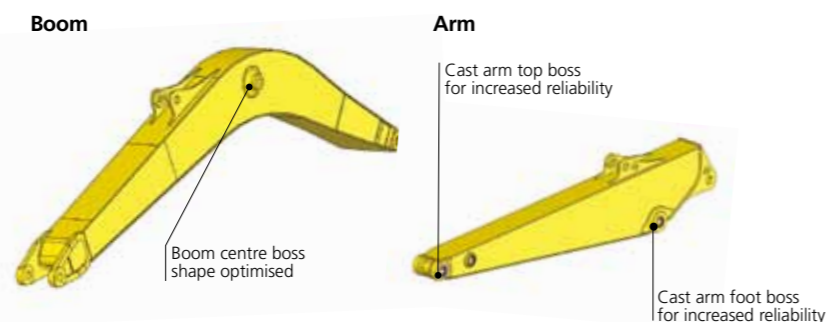

Ground Level Access to Engine Area Improves Preventative Maintenance

Parts cleaning and maintenance are possible from the ground without climbing onto the upper structure of the excavator body.

● Increased Cooling Capability

With the larger radiator and oil cooler, cooling capacity is increased, thus improving reliability. In addition, cleaning of the dust-proof net is simplified.

● Easy Filter Replacement

A fuel prefilter and clogging sensor to the main fuel filter are provided as standard equipment to reduce trouble due to fuel clogging. In addition, the fuel and oil filters are installed at ground-accessible location to facilitate replacement.

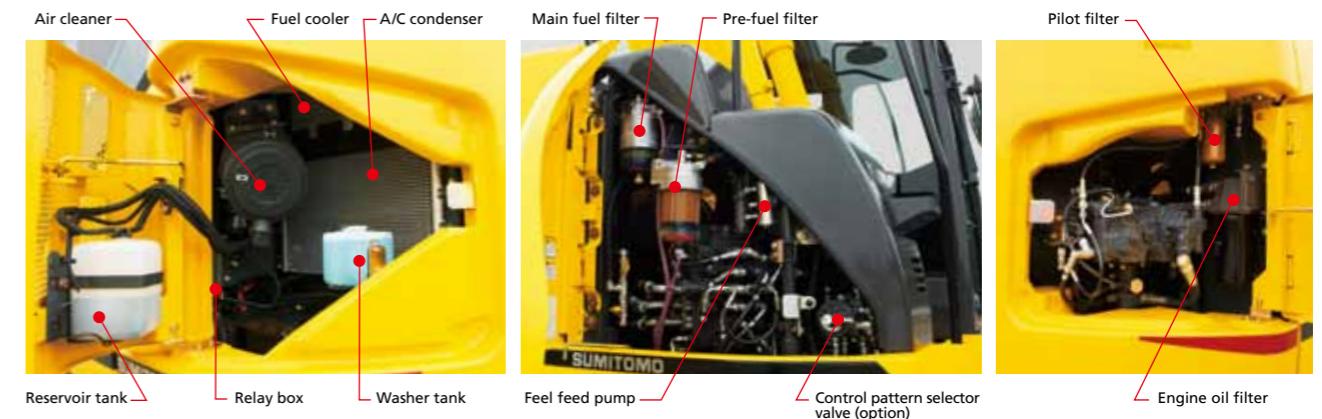

High-Performance Return Filter

The hydraulic oil change interval is 5,000 hours, and the return filter change interval is 2,000 hours. One high performance return filter keeps the same level of filtering as a nephron.



- **Hydraulic oil change: 5,000 hours**

- **Life of filter: 2,000 hours**

* The oil and filter change interval varies depending on the working conditions.

Cab Floor Mat

SUMITOMO
UNIQUE DESIGN

The washable floor mat has been redesigned for ease of removing and cleaning.



Easy Access to A/C Filter

The air intake filter is located in a lockable compartment to make it easier to replace, and access to the inside cab filter has been simplified.



Fuse Box Location

The fuse box has been located in a separate compartment behind the seat, allowing easier access.





Safety and Operator Comfort

The cabin provides Roll Over Protective Structure (ROPS) in compliance with ISO 12117-2:2008. This enhanced protection comes standard from the factory.

The cabin is also compliant to OPG Top Guard Level 1.

To support the operator in the field, the DASH 6 incorporates a 7" wide full colour LCD monitor with numerous functions and universally designed switch panel.

The ROPS compliant cabin with enhanced operator comfort ensures a safe working environment.

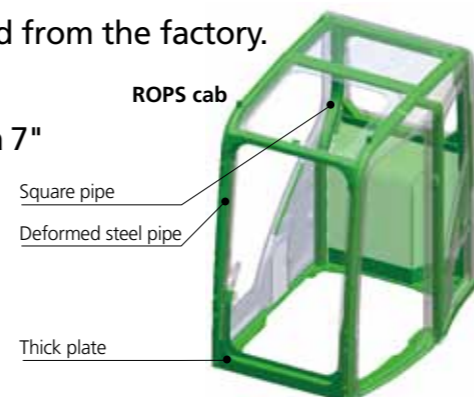

Wide View Increases Safety of Work

In addition to the wide front view, the upper view has been widened to enhance work safety.

Rearview Camera

With the standard rearview camera, the operator can view the image on the large LCD monitor. A side camera is available as an optional extra and up to two different images can be displayed on the monitor.



Side camera (option)



Rearview camera (standard)

Safe and Easy Entry into and Exit from the Cab

A large handrail for easy opening/closing of the door and increased floor space permit the operator to get in and out of the cab easily.



Easy Access to the Upper Structure



New larger front-right step



ISO-compliant large handrail



Non-slip plate

New OPG Level 2 Head Guard

OPG Level 2 head guard is available as an option. The see-through grille has been redesigned for better protection and visibility.



ISO Compliant Rearview Mirror

The new ISO compliant rearview mirrors reduce blind spots during operation. Together with the front mirrors, visibility is secured for safe operation.



Front/Side mirror



Rearview mirrors

Safety Equipment



Anti-theft alarm system



Emergency stop switch



Large High-Definition LCD Monitor

A new large high-definition full colour LCD monitor has been introduced with better visibility and a switch panel which is easy to operate. Added functionality such as ECO gauge showing parameter of energy saving, display of operation status and warning messages, provides accurate information which improves work efficiency and safety.

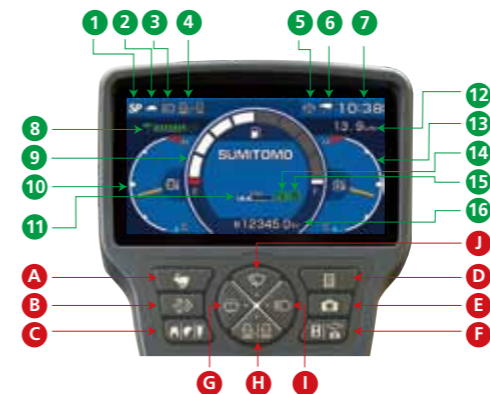

Indicators

- 1 Working modes
- 2 Travel speed
- 3 Work lights
- 4 Engine idle modes
- 5 Anti-theft
- 6 Attachment selection
- 7 Digital clock
- 8 ECO gauge
- 9 Fuel level gauge
- 10 Engine coolant temperature
- 11 DPD status gauge
- 12 Fuel consumption indicator
- 13 Hydraulic oil temperature
- 14 Power boost
- 15 Radio mute
- 16 Hour meter

Switch Panel

- A Travel speed button
- B Manual regen button
- C Aux. hydraulics settings
- D Computer menu
- E Camera on/off
- F Hour meter / Camera toggle button
- G Window washer control
- H Engine idle mode button
- I Worklights on/off
- J Window wiper control

Super Comfortable Cab Mounts and Pressurised Cab

Fluid mounts that support the cab absorb shocks and vibrations effectively, improving ride comfort. The cab also features a pressurised design to prevent dust from entering inside, giving operators greater comfort.

Fluid mount

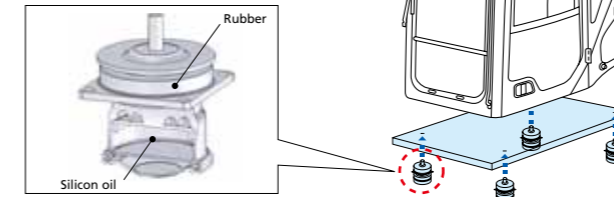

Automatic Air Conditioner

An automatic air conditioner is included to keep the cab interior at the ideal temperature. The sealed, pressurised cab helps to increase air conditioner efficiency.



Operating panel

Radio and Speaker with MP3 Jack

In addition to the AM/FM radio and dual speaker system with improved sound quality, auxiliary audio port is provided standard for devices such as MP3 players.



Operating panel

Ample Legroom and Comfortable Seats

Legroom around the cab has been increased for comfortable operations. The operator seat features a head rest and arm rests, and comes with a wide range of seat adjustment functions with a comfortable suspension system.



Air suspension seat (option)

Comfortable Equipment

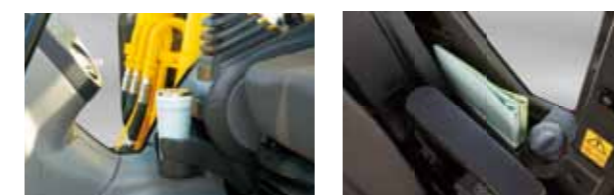

Cup holder

Magazine rack

Roof Window for Greater Freedom

A new pop-up roof window (made of polycarbonate) with sun shade has been installed for greater comfort.



Under-cab Storage Space

Storage space has been included under the cab for various tools.



Safety and Operator Comfort

The spacious cab on fluid mounts and reclining suspension seat help reduce operator fatigue and provide a relaxed environment.



Specifications

SH145X-6 Technical Data

Electronic-controlled engine of SPACE 5+ and SIH:S+ with New Hydraulic System Includes: three working modes (SP,H,A), one-touch/automatic idling system, automatic power-boost.

Engine

SH145X-6	
Model	ISUZU AM-4JJ1X
Type	Water-cooled, 4-cycle diesel, 4-cylinder in line, high pressure common rail system (electric control), turbocharger with air cooled intercooler, DPD system.
Rated output	74.9 kW /2,000 min ⁻¹
Maximum torque	359 N·m at 1,600 min ⁻¹
Piston displacement	2.999 ltr
Bore and stroke	95.4 mm x 104.9 mm
Starting system	24 V electric motor starting
Alternator	24 V, 50 A
Fuel tank	200 ltr
Air filter	Double element

Hydraulic pumps

Two variable displacement axial piston pumps provide power for boom/arm/bucket, swing, and travel. One gear pump for pilot controls.

SH145X-6	
Maximum oil flow	2 x 129 ltr/min
Pilot pump max.oil flow	20 ltr/min

Hydraulic motors

For travel: Two variable displacement axial piston motors.
For swing: One fixed displacement axial piston motor.

Relief valve settings

Boom/arm/bucket34.3 MPa (350 kgf/cm²)
Boom/arm/bucket36.3 MPa (370 kgf/cm²) with auto power-up
Swing circuit28.0 MPa (286 kgf/cm²)
Travel circuit34.3 MPa (350 kgf/cm²)

Control valve

With boom/arm holding valve
One 4-spool valve for right track travel, bucket, boom and arm acceleration
One 5-spool valve for left track travel, auxiliary, swing, boom acceleration and arm
One 1-spool valve for blade

Oil filtration

Return filter 6 microns
Pilot filter 8 microns
Suction filter 105 microns

Hydraulic cylinders

Cylinder	Q'ty	Bore x Rod Diameter x Stroke
Boom	2	105 mm x 75 mm x 1120 mm
Arm	1	115 mm x 80 mm x 1108 mm
Bucket	1	95 mm x 65 mm x 881 mm
Blade	2	115 mm x 70 mm x 250 mm

Double-acting, bolt-up type cylinder tube-end; hardened steel bushings installed in cylinder tube and rods ends.

Cab & controls

Roll-over protective structure (ROPS) cab, top guard OPG level1 (in cab structure). Cab mounted on four fluid mountings. Features include safety glass front, rear and side windows, adjustable upholstered suspension seat with headrest and armrest, cigarette lighter, pop-up skylight window, and intermittent wiper with washer. Front window slides upward for storage and the lower front window is removable. Built-in type full-colour monitor display. Membrane switch on monitor display.

Swing

Planetary reduction powered by axial piston motor. The internal ring gear with grease cavity for pinion. Swing bearing is single-row shear type ball bearing. Dual stage relief valves for smooth swing deceleration and stops. Mechanical disc swing brake.

SH145X-6	
Swing speed	0~11.2 min ⁻¹
Tail swing radius	1,490 mm
Swing torque	37.0 kN·m (3,773 kgf·m)

Undercarriage

X-style carbody is integrally welded for strength and durability. Grease cylinder track adjusters with shock absorbing springs. Undercarriage with lubricated rollers and idlers.

Type of shoe: sealed link shoe

Upper rollers -

Heat treated, mounted on steel bushings with leaded tin bronze casting, sealed for lifetime lubrication.

Lower rollers -

Heat treated, mounted on steel bushings with leaded tin bronze casting, sealed for lifetime lubrication.

Track adjustment -

Idler axles adjusted with grease cylinder integral with each side frame; adjustment yoke mechanism fitted with heavy duty recoil spring.

Number of rollers and shoes on each side

SH145X-6	
Upper rollers	1
Lower rollers	7
Track shoes	43

Travel system

Two-speed independent hydrostatic system with compact axial motors for increased performance. Hydraulic motor powered output shaft coupled to a planetary reduction unit and track sprocket. All hydraulic components mounted within the width of side frame.

Travel speed can be selected by switch panel.

Hydraulically released disc parking brake is built each motor.

SH145X-6		
Travel speed	High	5.6 km/h
	Low	3.4 km/h
Drawbar pull		116 kN (11,829 kgf)

Lubricant & coolant capacity

SH145X-6	
Hydraulic system	158 ltr
Hydraulic oil tank	75 ltr
Fuel tank	200 ltr
Cooling system	15.3 ltr
Final drive case (per side)	2.1 ltr
Swing drive case	3.0 ltr
Engine crank case	17.0 ltr

Auxiliary hydraulic system

SH145X-6			
Auxiliary piping type (option)	For Breaker	For Double (breaker & crusher) acting	For D/A + Second option line
Arm type	STD	HD	HD
Bucket linkage type	HD	HD	HD
Auxiliary hydraulic pump flow	129 ltr/min	258 ltr/min	258+63 ltr/min

Bucket

Model	SH145X-6							
Bucket capacity (ISO/SAE/PCSA heaped)	0.24 m ³	0.30 m ³	0.37 m ³	0.45 m ³	0.50 m ³	0.55 m ³	0.65 m ³	
Bucket capacity (CECE heaped)	0.22 m ³	0.28 m ³	0.34 m ³	0.40 m ³	0.45 m ³	0.50 m ³	0.60 m ³	
Bucket type	STD	STD	STD	STD	Reinforced	STD	Reinforced	STD
Number of teeth	4	4	4	4	5	5	5	5
Width (mm)	With side cutter	582	692	772	907	972	1057	1192
	Without side cutter	508	618	698	833	898	983	1118
Weight (kg)		285	322	340	368	404	395	441
	2.11 m arm	○	○	○	○	○	○	●
Combination	2.50 m arm	○	○	○	○	○	●	○
	3.01 m arm	○	○	●	○	○	△	×

○ Suitable for materials with density up to 2,000 kg/m³ or less

○ Suitable for materials with density up to 1,600 kg/m³ or less

● Standard bucket (suitable for materials with density up to 1,800 kg/m³ or less)

Weight & Ground Pressure

Model	SH145X-6			
Shoe type	Shoe width	Overall width	Operating weight	Ground pressure
Triple grouser shoe	500 mm	2,490 mm	14 600 kg	47 kPa
	600 mm	2,590 mm	14 800 kg	40 kPa
	700 mm	2,690 mm	15 100 kg	35 kPa

Digging Force

Model	SH145X-6			
Arm length		2.11 m (w/power boost)	2.50 m (w/power boost)	3.01 m (w/power boost)
Bucket digging force	ISO 6015	89.7 kN (94.9 kN)	89.7 kN (94.9 kN)	89.7 kN (94.9 kN)
	SAE: PCSA	80.1 kN (84.8 kN)	80.1 kN (84.8 kN)	80.1 kN (84.8 kN)
Arm digging force	ISO 6015	70.0 kN (74.0 kN)	62.3 kN (65.9 kN)	56.2 kN (59.5 kN)
	SAE: PCSA	67.8 kN (71.8 kN)	60.1 kN (64.1 kN)	54.9 kN (58.1 kN)

Lifting Capacity

Notes: 1. Ratings are based on ISO 10567

- Lifting capacity does not exceed 75% of tipping load with the machine on firm, level ground or 87% full hydraulic capacity.
- The load point is a hook (not standard equipment) located on the back of the bucket.
- *Indicates load limited by hydraulic capacity.
- 0 m = Ground.

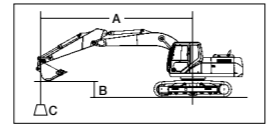

A: Radius of load
B: Bucket hook height
C: Lifting capacity

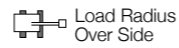

Unit : kg

SH145X-6

SHOE : 500 (mm)G
BUCKET : SAE/PCSA 0.55 (m³)
ARM LENGTH : 2.11 (m)
MAXIMUM REACH : 7.94 (m)
BOOM : 4.63 (m)
BLADE : Up

Bucket Hook Height	Max. Radius		7.5 m		6 m		4.5 m		3 m		1.5 m		Min. Radius			
	(kg)	(m)	(kg)	(m)	(kg)	(m)	(kg)	(m)	(kg)	(m)	(kg)	(m)	(kg)	(m)		
7.5 m	1 620*	4.63	1 620*	4.63			1 990*	1 990*					1 670*	3.01	1 670*	3.01
6 m	1 350*	6.26	1 350*	6.26			2 190*	2 190*	3 210*	3 210*			3 530*	3.3	3 530*	3.3
4.5 m	1 260*	7.14	1 260*	7.14			2 940	2 180	4 390*	3 580	4 610*	4 610*	2 450*	2.45	2 450*	2.45
3 m	1 260*	7.57	1 260*	7.57	1 630*	1 380	2 840	2 090	4 610	3 360	8 050*	6 570	6 510*	1.94	6 510*	1.94
1.5 m	1 330*	7.65	1 290	7.65	1 870	1 340	2 720	1 970	4 340	3 120	8 750	5 830	3 910*	2.46	3 910*	2.46
0 m	1 490*	7.41	1 340	7.41			2 620	1 890	4 140	2 930	7 640*	5 480	3 050*	1.87	3 050*	1.87
-1.5 m	1 810*	6.82	1 540	6.82			2 600	1 860	4 090	2 890	8 380	5 540	5 600*	0.63	3 970*	0.63
-3 m	2 520*	5.8	2 010	5.8					4 150	2 970	7 180*	5 660	8 340*	0.89	7 030*	0.89
-4.5 m	2 270*	3.79	2 270*	3.79							3 090*	3 090*	3 150*	2.9	3 150*	2.9

SH145X-6

SHOE : 500 (mm)G
BUCKET : SAE/PCSA 0.55 (m³)
ARM LENGTH : 2.11 (m)
MAXIMUM REACH : 7.94 (m)
BOOM : 4.63 (m)
BLADE : Down

Bucket Hook Height	Max. Radius		7.5 m		6 m		4.5 m		3 m		1.5 m		Min. Radius			
	(kg)	(m)	(kg)	(m)	(kg)	(m)	(kg)	(m)	(kg)	(m)	(kg)	(m)	(kg)	(m)		
7.5 m	1 620*	4.63	1 620*	4.63			1 990*	1 990*					1 670*	3.01	1 670*	3.01
6 m	1 350*	6.26	1 350*	6.26			2 190*	2 190*	3 210*	3 210*			3 530*	3.3	3 530*	3.3
4.5 m	1 260*	7.14	1 260*	7.14			3 340*	2 270	4 390*	3 710	4 610*	4 610*	2 450*	2.45	2 450*	2.45
3 m	1 260*	7.57	1 260*	7.57	1 630*	1 450	4 410*	2 170	5 560*	3 500	8 050*	6 870	6 510*	1.94	6 510*	1.94
1.5 m	1 330*	7.65	1 330*	7.65	2 180*	1 410	4 810*	2 060	6 510*	3 250	10 000*	6 110	3 910*	2.46	3 910*	2.46
0 m	1 490*	7.41	1 410	7.41			4 850*	1 970	6 720*	3 070	7 640*	5 760	3 050*	1.87	3 050*	1.87
-1.5 m	1 810*	6.82	1 610	6.82			4 450*	1 950	6 340*	3 020	9 360*	5 820	5 600*	0.63	3 970*	0.63
-3 m	2 520*	5.8	2 100	5.8			4 980*	3 100	7 180*	5 920	8 340*	8 340*	7 030*	0.89	7 030*	0.89
-4.5 m	2 270*	3.79	2 270*	3.79					3 090*	3 090*			3 150*	2.9	3 150*	2.9

SH145X-6

SHOE : 500 (mm)G
BUCKET : SAE/PCSA 0.5 (m³)
ARM LENGTH : 2.50 (m)
MAXIMUM REACH : 8.29 (m)
BOOM : 4.63 (m)
BLADE : Up

Bucket Hook Height	Max. Radius		7.5 m		6 m		4.5 m		3 m		1.5 m		Min. Radius			
	(kg)	(m)	(kg)	(m)	(kg)	(m)	(kg)	(m)	(kg)	(m)	(kg)	(m)	(kg)	(m)		
7.5 m	1 310*	5.24	1 310*	5.24			2 380*	2 380*					1 850*	3.42	1 850*	3.42
6 m	1 110*	6.7	1 110*	6.7			2 340*	2 280*	2 980*	2 980*			3 250*	3.68	3 250*	3.68
4.5 m	1 050*	7.52	1 050*	7.52	1 110*	1 110*	2 960*	2 240	3 710*	3 590			3 680*	3.18	3 680*	3.18
3 m	1 060*	7.92	1 060*	7.92	1 960	1 430	2 900	2 140	4 690*	3 450	7 280*	6 680	6 820*	1.53	6 820*	1.53
1.5 m	1 120*	8	1 120*	8	1 910	1 380	2 770	2 020	4 430	3 200	9 000	6 040	3 620*	2.15	3 620*	2.15
0 m	1 250*	7.77	1 250*	7.77	1 860	1 340	2 660	1 920	4 200	3 000	8 340*	5 600	2 790*	1.43	2 630*	1.43
-1.5 m	1 510*	7.22	1 420	7.22			2 610	1 880	4 110	2 910	8 340	5 560	5 170*	0.24	3 590*	0.24
-3 m	2 070*	6.26	1 800	6.26			2 670	1 940	4 160	2 960	8 010*	5 660	8 120*	0.46	5 810*	0.46
-4.5 m	2 230*	4.69	2 230*	4.69							2 680*	2 680*	4 540*	1.77	5 770*	1.77

Lifting Capacity

Notes: 1. Ratings are based on ISO 10567

- Lifting capacity does not exceed 75% of tipping load with the machine on firm, level ground or 87% full hydraulic capacity.
- The load point is a hook (not standard equipment) located on the back of the bucket.
- *Indicates load limited by hydraulic capacity.
- 0 m = Ground.

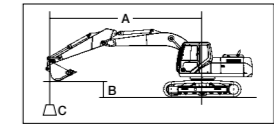

A: Radius of load
B: Bucket hook height
C: Lifting capacity



Unit : kg

SH145X-6

SHOE : 500 (mm)G
BUCKET : SAE/PCSA 0.5 (m³)
ARM LENGTH : 2.50 (m)
MAXIMUM REACH : 8.29 (m)
BOOM : 4.63 (m)
BLADE : Down

Bucket Hook Height	Max. Radius		7.5 m		6 m		4.5 m		3 m		1.5 m		Min. Radius			
	(kg)	(m)	(kg)	(m)	(kg)	(m)	(kg)	(m)	(kg)	(m)	(kg)	(m)	(kg)	(m)		
7.5 m	1 310*	5.24	1 310*	5.24			2 380*	2 380*					1 850*	3.42	1 850*	3.42
6 m	1 110*	6.7	1 110*	6.7			2 340*	2 340*	2 980*	2 980*			3 250*	3.68	3 250*	3.68
4.5 m	1 050*	7.52	1 050*	7.52	1 110*	1 110*	2 960*	2 330	3 710*	3 710*			3 680*	3.18	3 680*	3.18
3 m	1 060*	7.92	1 060*	7.92	2 320*	1 490	3 880*	2 230	5 290*	3 590	7 280*	6 960	6 820*	1.53	6 820*	1.53
1.5 m	1 120*	8	1 120*	8	2 780*	1 440	4 750*	2 110	6 350*	3 330	9 830*	6 330	3 620*	2.15	3 620*	2.15
0 m	1 250*	7.77	1 250*	7.77	2 490*	1 400	4 890*	2 010	6 770*	3 130	8 340*	5 880	2 790*	1.43	2 630*	1.43
-1.5 m	1 510*	7.22	1 480	7.22			4 670*	1 960	6 550*	3 050	9 630*	5 840	5 170*	0.24	3 590*	0.24
-3 m	2 070*	6.26	1 880	6.26			3 540*	2 030	5 490*	3 090	8 010*	5 940	8 120*	0.46	5 810*	0.46
-4.5 m	2 230*	4.69	2 230*	4.69					2 680*	2 680*	4 540*	4 540*	5 770*	1.77	5 770*	1.77

SH145X-6

SHOE : 500 (mm)G
BUCKET : SAE/PCSA 0.37 (m³)
ARM LENGTH : 3.01 (m)
MAXIMUM REACH : 8.74 (m)
BOOM : 4.63 (m)
BLADE : Up

Bucket Hook Height	Max. Radius		7.5 m		6 m		4.5 m		3 m		1.5 m		0 m		Min. Radius	
	(kg)	(m)	(kg)	(m)	(kg)	(m)	(kg)	(m)	(kg)	(m)	(kg)	(m)	(kg)	(m)	(kg)	(m)
7.5 m	1 280*	5.96	1 280*	5.96			2 350*	2 350*					2 080*	3.95	2 080*	3.95
6 m	1 120*	7.25	1 120*	7.25			2 300*	2 300*	2 770*	2 770*			2 800*	4.18	2 800*	4.18
4.5 m	1 080*	8	1 080*	8	2 000*	1 510	2 740*	2 310	3 090*	3 090*			2 990*	3.77	2 990*	3.77
3 m	1 080*	8.38	1 080*	8.38	2 000*	1 470	2 950	2 190	4 260*	3 530	4 640*	4 640*	4 610*	2.04	4 610*	2.04
1.5 m	1 150*	8.46	1 110	8.46	1 930	1 400	2 810	2 060	4 500	3 260	8 960*	6 230	3 790*	2.08	3 790*	2.08
0 m	1 270*	8.24	1 140	8.24	1 870	1 340	2 680	1 940	4 230	3 020	8 510	5 630	2 850*	1.32	2 570*	1.32
-1.5 m	1 500*	7.72	1 260	7.72	1 850	1 320	2 600	1 860	4 080	2 890	8 260	5 470	4 730*	0	3 950*	0
-3 m	1 970*	6.84	1 540	6.84			2 630	1 890	4 100	2 910	8 320*	5 540	6 940*	0	5 160*	0
-4.5 m	2 450*	5.42	2 250	5.42					3 970*	3 000	5 970*	5 600	9 260*	0.91	8 250*	0.91

SH145X-6

SHOE : 500 (mm)G
BUCKET : SAE/PCSA 0.37 (m³)
ARM LENGTH : 3.01 (m)
MAXIMUM REACH : 8.74 (m)
BOOM : 4.63 (m)
BLADE : Down

Bucket Hook Height	Max. Radius		7.5 m		6 m		4.5 m		3 m		1.5 m		0 m		Min. Radius	
	(kg)	(m)	(kg)	(m)	(kg)	(m)	(kg)	(m)	(kg)	(m)	(kg)	(m)	(kg)	(m)	(kg)	(m)
7.5 m	1 280*	5.96	1 280*	5.96			2 350*	2 350*					2 080*	3.95	2 080*	3.95
6 m	1 120*	7.25	1 120*	7.25			2 300*	2 300*	2 770*	2 770*			2 800*	4.18	2 800*	4.18
4.5 m	1 080*	8	1 080*	8	2 000*	1 580	2 740*	2 400	3 090*	3 090*			2 990*	3.77	2 990*	3.77
3 m	1 080*	8.38	1 080*	8.38	2 570*	1 530	3 520*	2 280	4 260*	3 660	4 640*	4 640*	4 610*	2.04	4 610*	2.04
1.5 m	1 150*	8.46	1 150*	8.46	3 080*	1 460	4 590*	2 140	6 030*	3 400	8 960*	6 520	3 790*	2.08	3 790*	2.08
0 m	1 270*	8.24	1 200	8.24	3 290*	1 410	4 860*	2 020	6 680*	3 150	9 670*	5 920	2 850*	1.32	2 570*	1.32
-1.5 m	1 500*	7.72	1 320													

Principle Specifications

		SH145X-6
		STD Specifications
Base	Std. operating weight	14,600 kg
	Boom length	4.63 m
	Arm length	2.50 m
	Bucket capacity (ISO heaped)	0.50 m ³
	Shoe width	500 mm
Engine	Counterweight	3,500 kg
	Make & model	ISUZU AM-4JJ1X
	Rated output	74.9 kW/2,000 min ⁻¹
Hydraulic System	Piston displacement	2,999 ltr
	Main pump	2 variable displacement axial piston pumps with regulating system
	Max oil flow	2 × 129 ltr/min
	Max pressure	34.3 MPa
	(with auto power boost)	36.3 MPa
	Travel motor	Variable displacement axial piston motor
	Parking brake	Mechanical disc brake
	Swing motor	Fixed displacement axial piston motor
	Travel speed	5.6/3.4 km/h
	Drawbar pull	116 kN
Performance	Gradeability	70% <35° >
	Ground pressure	47 kPa
	Max swing speed	11.2 min ⁻¹
	Swing torque	37.0 kN·m (3,773 kgf·m)
	Bucket digging force (ISO 6015)	89.7 kN
	/with power boost	94.9 kN
Others	Arm digging force (ISO 6015)	62.3 kN
	/with power boost	65.9 kN
	Fuel tank	200 ltr
	Hydraulic oil tank	75 ltr

Standard Equipment

[Hydraulic system]

- SIH:S+ hydraulic system
- Operation mode (SP, H and A mode)
- Automatic 2-speed travel
- Automatic power boost
- Arm/boom/bucket reactivation circuit
- Automatic swing parking system
- High-performance return filter

[Cab/interior equipment]

- Roll-over protective structure (ROPS) cab
- Top guard OPG level 1 (in cab structure)
- 4-point fluid mounts
- Built-in type full-colour monitor display
- Open air introducing pressurised full-automatic air conditioner
- Defroster
- KAB seat
- Seat suspension
- Windscreen wiper (with intermittent operation function)
- Cup holder
- AM/FM radio (with muting function and AUX port)
- Radio mute/ Windscreen wiper one-touch control on joystick
- Clock
- Magazine rack
- Accessory case
- Floor mat
- Armrest & headrest
- Ashtray & cigarette lighter
- Cab light (Auto-OFF function)
- Coat hook

[Safety equipment]

- Rearview mirror (left/right)
- Rearview camera
- Emergency escape tool
- Retracting seat belt
- Gate lock lever
- Travel alarm (with on and off switch)
- Anti-theft alarm system
- Engine room firewall
- Fan guard
- Engine emergency stop switch
- Engine neutral start

[Others]

- Auto/one-touch idling
- Auto idle shutdown system
- EMS
- Long-life hydraulic oil
- Two lights (main unit and left of boom)
- Fuel filter (with water separator)
- Fuel prefilter (with water separator)
- Double-element air cleaner
- Grease-enclosed track link
- Large tool box
- A set of tools

Accessories (option)

■ Cab-top lights



■ Rain deflector



■ 12V power (DC-DC converter)



■ Air suspension (KAB seat)



■ Front guard (OPG level 1 or 2)



■ Head guard (OPG level 2)



■ Refuel pump

■ Hose burst check valve (HBCV) for boom/arm cylinders

■ Side camera

Working Range

SH145X-6			
Arm length	2.11 m (SHORT)	2.50 m (STD)	3.01 m (LONG)
Boom length	4.63 m		
A Max digging radius	7,940 mm	8,290 mm	8,740 mm
B Max digging depth	5,110 mm	5,510 mm	6,010 mm
C Max digging height	9,060 mm	9,340 mm	9,690 mm
D Max dumping height	6,660 mm	6,940 mm	7,290 mm
E Max vertical wall cut depth	4,560 mm	4,900 mm	5,280 mm
F Min front swing radius	1,890 mm	1,950 mm	2,330 mm
G Tail swing radius	1,490 mm		

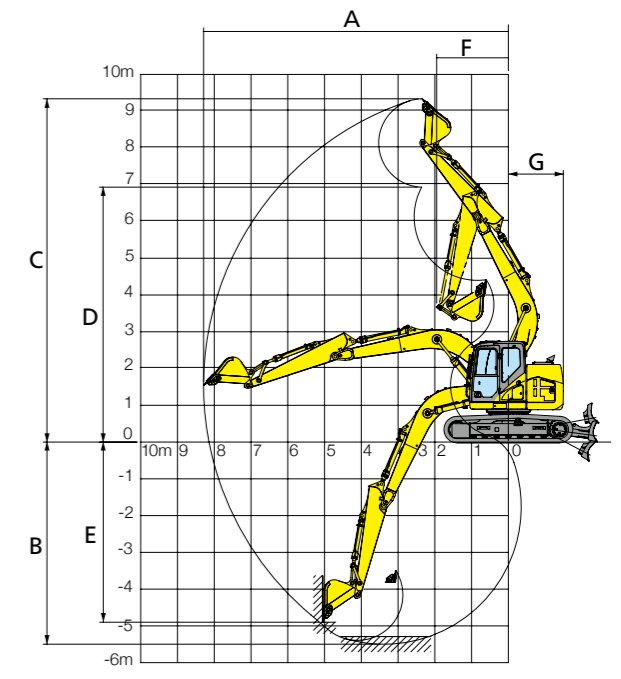

Dimensions

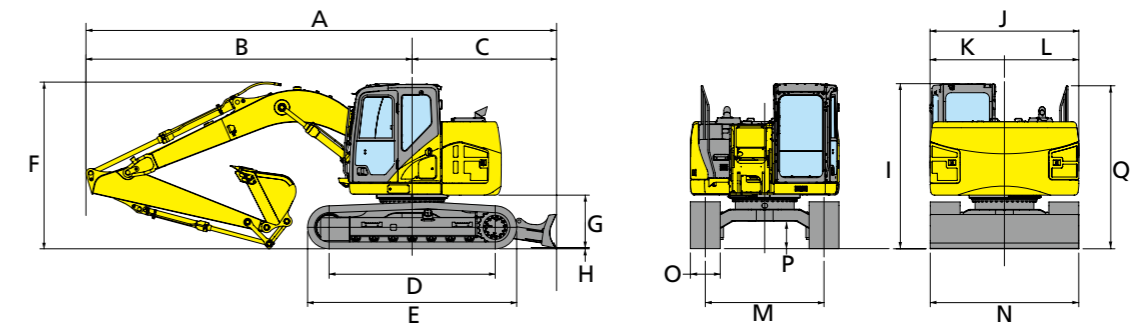

Model	SH145X-6		
Arm length	2.11 m	2.50 m	3.01 m
A Overall length	7,870 mm	7,880 mm	7,840 mm [*]
B Length from centre of machine (to arm top)	5,460 mm	5,470 mm	5,430 mm [*]
C Upper structure rear end radius	2,410 mm	2,410 mm	2,410 mm
D Centre to centre of wheels	2,790 mm	2,790 mm	2,790 mm
E Overall track length	3,500 mm	3,500 mm	3,500 mm
F Overall height (to top of boom)	2,720 mm	2,790 mm	2,600 mm [*]
G Clearance height under upper structure	880 mm	880 mm	880 mm
H Shoe lug height	20 mm	20 mm	20 mm
I Overall height (to top of cab)	2,770 mm	2,770 mm	2,770 mm
J Upper structure overall width	2,490 mm	2,490 mm	2,490 mm
K Width from centre of machine (left side)	1,240 mm	1,240 mm	1,240 mm
L Width from centre of machine (right side)	1,250 mm	1,250 mm	1,250 mm
M Track gauge	1,990 mm	1,990 mm	1,990 mm
N Overall width	2,490 mm	2,490 mm	2,490 mm
O Std. shoe width	500 mm	500 mm	500 mm
P Minimum ground clearance	440 mm	440 mm	440 mm
Q Overall height (to top of handrail)	2,730 mm	2,730 mm	2,730 mm

^{*} For 3.01 m arm - arm cylinder pin at transportation point.